

BELMONDO® Kingsize Duo

prerequisites:



concrete:

- min. 10 cm thick
- no holes
- no elevations

mats:

even temperature:
min. 5° C to max. 30° C
(Store accordingly!)

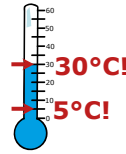

To bind fluids (urine) a small amount of absorbent bedding is always required in the loosebox.

You will need this:

measuring:

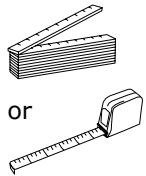

marking:

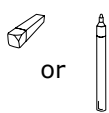

cutting:

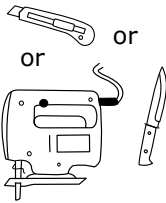

drilling and installing:

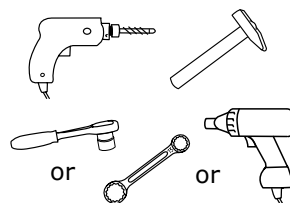

KRAIBURG fastening elements:



nail plugs \varnothing 10 x 80 mm with

- corresponding washers \varnothing 30 mm - A2

with VITA Top:

hexagon screw \varnothing 5 x 60 mm

with maxiPROFIL:

framing plugs \varnothing 10 x 100 mm

(fastening elements are part of delivery)

Possible installation variations on the edge:

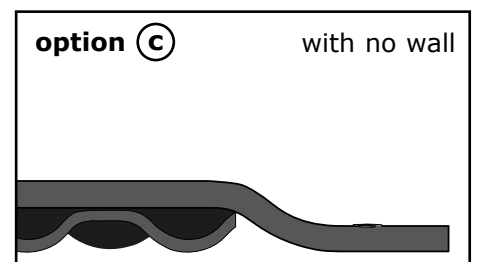
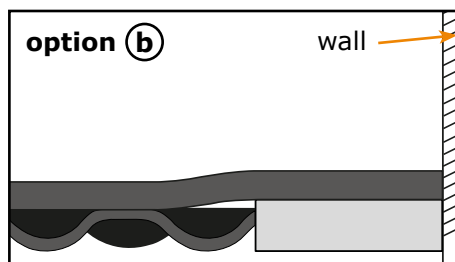
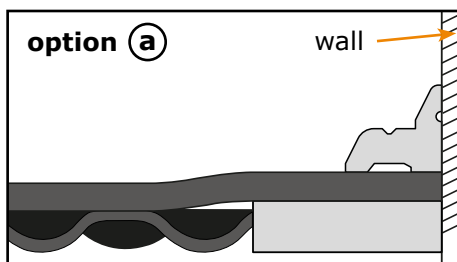

1 Install bottom floor

- I fit in plastic boards and fasten each board 2 x
> **nail plugs 10 x 80 mm**

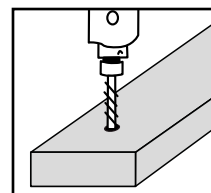
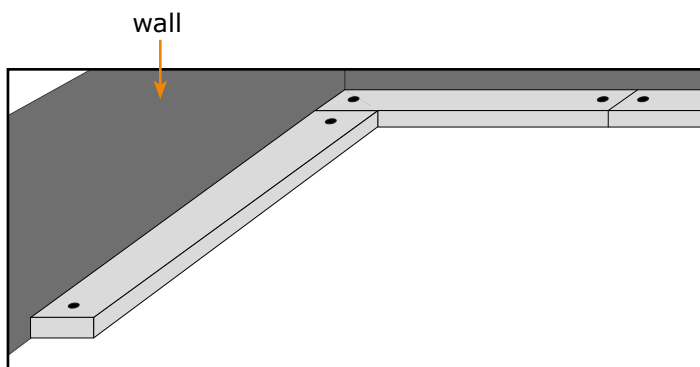

drilling

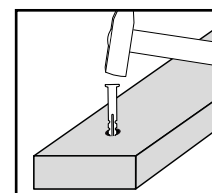

pound the plastic plugs in flush

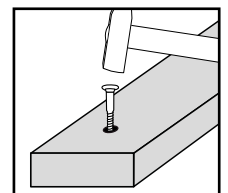

pound nails **without** washers in flush

II fit in BELMONDO® Cup (lower mats)

open cups on upper side

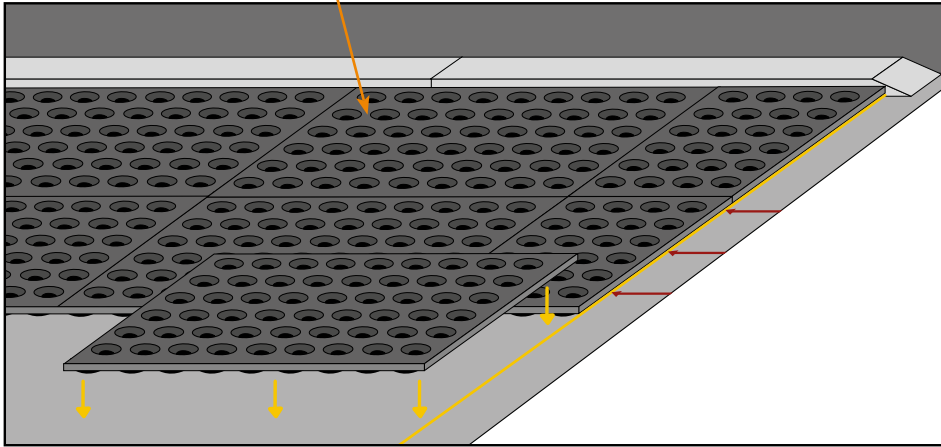

install lower mats seamlessly throughout the whole area, with no plastic board on the sides (option **C**) place the lower mats 10 cm from the edge. If necessary, cut mats to fit

tip:
chamfer plastic board

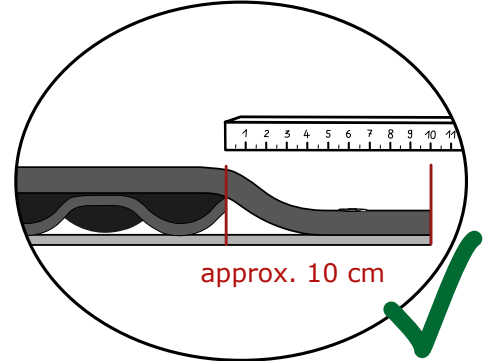

distance to side edge: approx. 10 cm

lower mats can be adjoined cross- and/or lengthwise

2 Cut and position BELMONDO® Kingsize Cover (top covering)

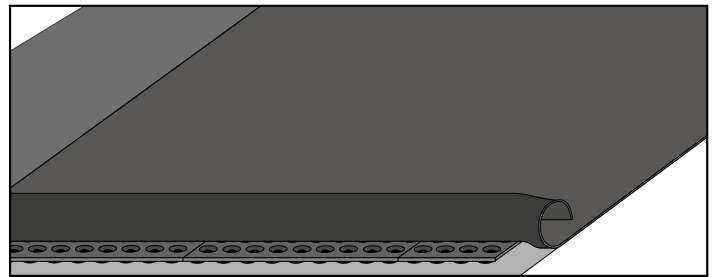
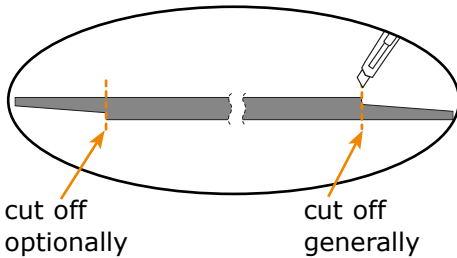
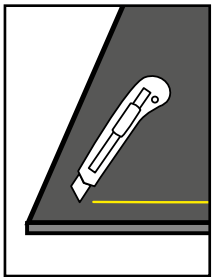

3 Fasten BELMONDO® Kingsize Cover (top covering)
> nail plugs 10 x 80 mm

with option **a** (with covering strip): fasten every 50 cm

with option **b** + **c** (with no covering strip): fasten every 20 cm

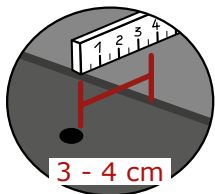

distance to wall: 3 - 4 cm

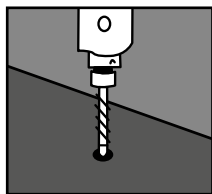

drilling

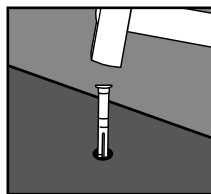

pound the plastic plugs in flush

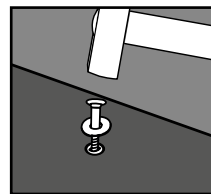

pound in nails and washers until they are seated evenly fast and are slightly countersunk

Option a :

I lay covering strips onto the top covering along the walls

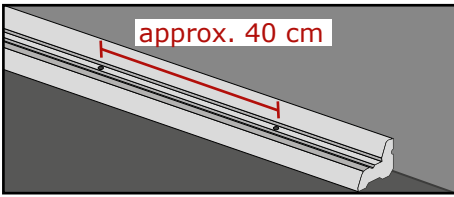

- high end outwards
- flush to wall

II fasten approx. every 40 cm
> **spax screw 5 x 60 mm**

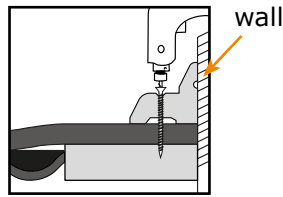

! fasten screws until they are seated evenly fast.
Do not overtighten!

Optional: the groove in the back of VITA Top can be filled with a round cord Ø 6 mm

4 At joints: screw maxiPROFIL

I place profiles centrally on mat joint

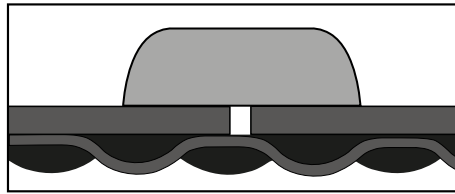
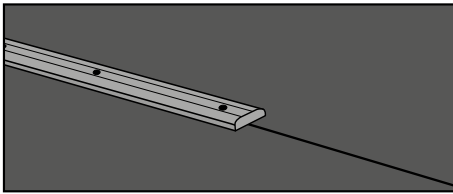

i placing the mat joint is independent of the placing of the lower mats

II fasten maxiPROFIL
> **framing plugs 10 x 100 mm**

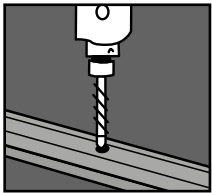

drilling

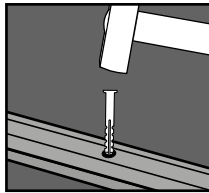

pound the plastic plugs in flush

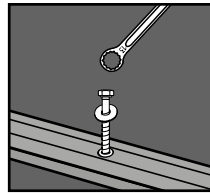

fasten screws and washers until they are seated evenly fast.
Do not overtighten!

! use every fastening hole!

i tip:
avoid profile slippage:
1. drill first hole
2. pound in a plug (-> fixation)
3. afterwards drill further holes and so on

i Appropriate installation may differ due to local conditions. Therefore the manufacturer is not liable for installation!